



## Operating Instruction Flow Monitor / Flow Indicator DKG, viscosity compensated

Operation: float measuring principle

### Content

1.	Preface	2
2.	Safety hints	2
3.	Principle of operation	2
4.	Installation	3
5.	Electrical connection	4
6.	Switch point adjustment	7
7.	Maintenance	7
8.	Troubleshooting guide	8
9.	Specifications	9



- Universal orientation
- Viscosity compensated
- High switch accuracy
- Infinitely variable switch point adjustment through user
- EX-version to ATEX available
- Scales are burnt into the sight glass
- Threaded connection, special threads on request



## Operating Instruction Flow Monitor / Flow Indicator DKG, viscosity compensated

Operation: float measuring principle

### 1. Preface

The flow monitors type DKG are characterized by reliability and simple handling. To use the advantages of the instrument to the full extent, please take notice of the following:

**Every person, in charge of commissioning and operation of this instrument, must read and understand the operating instruction and specifically the safety information!**

### 2. Safety hints

#### 2.1. General information

The instructions contained in the operating manual must be followed to ensure a safe operation of the instrument. Furthermore, the additional legal- and safety-regulations for the individual application must be observed. Accordingly, this applies for the use of accessories as well.

#### 2.2. Intended use

The instruments of type DKG serve as monitors for continuous flow of viscous liquids. Any other use counts as improper. If not indicated otherwise, the scaling of the instruments refers to mineral oil. Special applications, where intermittent loads (e.g. cyclic operation) could occur, should be discussed and checked with our technical staff.

The instruments of type DKG should not be used as a single source to avoid dangerous situations on machinery and in plants.

Machinery and plants must be constructed so that faulty conditions do not lead to dangerous situations for the operator.

#### 2.3. Qualified personnel

The instruments of type DKG must only be installed by qualified personnel, who are capable of using these instruments in a professional manner. Qualified personnel are such persons, who are familiar with the installation, assembly, commissioning and operation of these instruments and who hold a corresponding qualification for this function.

### 3. Principle of operation

Instruments of type DKG operate on the principle of the float type flow indicator. Through the flowing medium a float is set in motion, whose integrated magnets create a magnetic field. The position of the float is detected with the switch contact. The float is reset to the starting point by



## Operating Instruction

### Flow Monitor / Flow Indicator DKG, viscosity compensated

Operation: float measuring principle

means of a spring, which allows the installation at any position in a system. The instruments are calibrated for the installation with flow from bottom to top. The weight of the float induces the measuring result, therefore a different mounting position will show discrepancies to the actual flow.

## 4. Installation

### 4.1. Process connection

Attention! To avoid damage of the flow monitor or the installation the following requirements must be fulfilled under any circumstances:

- Suitable process connection to be provided by the customer
- Connection size needs to be checked
- Thread depth needs to be checked
- Suitable sealing material to be used (liquid sealing material will damage the flow monitor if it gets inside)
- Professional sealing necessary

### 4.2. Environmental conditions

- The flow monitor must not be used as a supporting part in a pipe construction.
- The medium must not contain any solid particles. Magnetic particles will accumulate at the magnetic float and effect the function.
- Before application of anti-freeze and anti-corrosive agents check their compatibility.
- External magnetic fields will influence the switch contact. Keep sufficient distance to magnetic fields (e.g. electric motors).

Warning! The following requirements must be adhered to, otherwise the function of the flow meter will be affected or the measuring results will be falsified:

- Piping, process connections or supports made from ferromagnetic material influence the magnetic field of the flow monitor. Keep a distance of 100mm to those materials (e.g. steel).
- The accuracy is influenced by cross-section changes, branches or elbows in the piping. Provide a straightening section of 10x DN upstream and 5x DN downstream of the instrument. Never reduce the pipe diameter direct ahead of the instrument!
- With liquids take suitable steps for the de-aeration of the instrument.



## Operating Instruction Flow Monitor / Flow Indicator DKG, viscosity compensated

Operation: float measuring principle

### 5. Electrical connection

The switch contacts are potential-free and do not need any power supply.

Attention! Switch contact and unit are matched. After replacing a switch contact a readjustment must be made. Please request the corresponding assembly instructions!

Switch position under No flow condition:

**Connection: normally open**

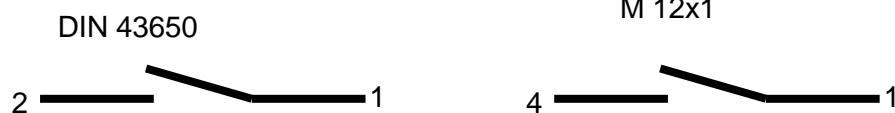

**Connection: change-over**

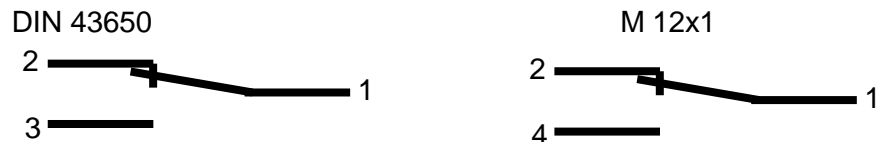

#### 5.1. Standard switch contact

Pin-allocation of the supplied socket (DIN 43650 Form A or C). The Ground-pin is not used.

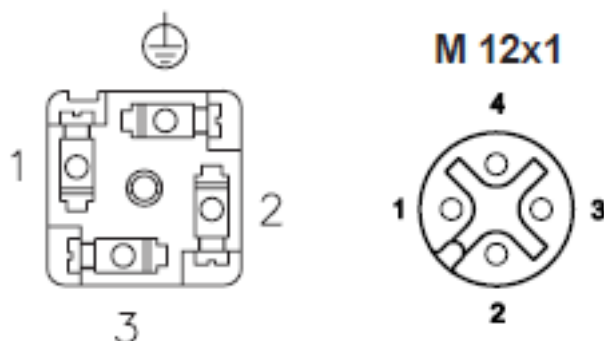

**Important instruction:**

**When using the socket DIN 43650, the ingress protection IP65 is only warranted in connection with a suitable cable diameter.**

**For information please refer to page 10.**



## Operating Instruction Flow Monitor / Flow Indicator DKG, viscosity compensated

Operation: float measuring principle

### 5.2. Switch contact with cable

The individual cores of the cable are marked according to the above connection diagram.

### 5.3. Special design

On request special designed switch contacts (socket, ready-made cable) can be supplied.

### 5.4. EEx-proof switch contacts

Attention!

For the connection of Eex-proof switch units special instructions apply, which must be followed! Pay attention to the hints in the separate operation instruction for Eex-proof switch contacts!

### 5.5. Contact precaution

Attention!

The following requirements must be adhered to under any circumstances, otherwise the switch contact will be destroyed!

The reed contacts employed in the switch contacts are, due to their construction, very sensitive against overload. None of the values of voltage, current and wattage may exceed/overshoot (not even for a fractional moment).

The danger of overloads exists by means of:

- Inductive loads
- Capacitive loads
- Resistive loads

#### Inductive load

The kind of load will be caused by:

- Contactors, relays
- Solenoid valves
- Electric motors

#### Danger:

Voltage peaks during switch off (up to 10 times of the nominal voltage)



## Operating Instruction Flow Monitor / Flow Indicator DKG, viscosity compensated

Operation: float measuring principle

### Precautionary measure (examples):

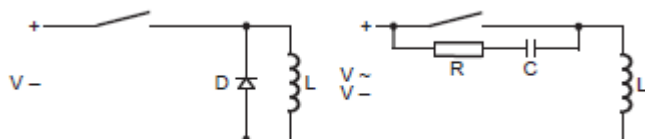

### Capacitive load

This kind of load will be caused by:

- Extreme long connection cables
- Capacitive consumption

### Danger:

High current peaks when turning on the switch contact (exceeding the nominal current)

### Precautionary measure (example):

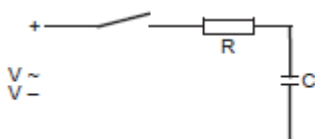

Limiting the current by means of a resistor

### Resistive load

This kind of load will be caused by:

- Incandescent bulbs
- Motor start up

**Danger:** High current peaks when turning on the switch contact, as the glow filament has a lower resistance at low temperatures.

### Precautionary measure (examples):

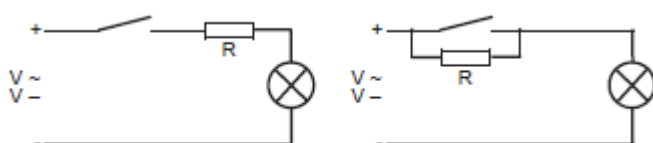

Limiting the current by means of a resistor or heating of the glow filament.

### Connection to SPS

For the connection to high resistance devices (like SPS) a protection circuit is not necessary.



## Operating Instruction Flow Monitor / Flow Indicator DKG, viscosity compensated

Operation: float measuring principle

### 6. Switch point adjustment

- Loosen the lock screw of the switch contact and shift the switch contact up to the stopper against the direction of the flow. The switch contact should be closed.
- Adjust the desired flow rate. In case the flow monitor is not installed, use a non-magnetic rod (e.g. pencil) to shift the float in flow direction to achieve a congruence with the graduation of the desired flow rate on the scale (upper edge of float = reference point).
- Shift the switch contact in flow direction until the contact opens.
- Tighten the lock screw of the switch contact.

### Notes

- The adjusted switch point corresponds to the switch off point of the switch contact with decreasing flow.
- The actual switch position can be determined by a continuity tester.
- The above description of the adjustment refers to the normally open contact.

### 7. Maintenance

Due to the few movable parts, the instruments do not require much service. A functional check and service on a regular base will not only increase the life time and reliability of the instrument, but also that of the entire plant.

The service intervals depend on

- The pollution of the media
- Environmental conditions (e.g. vibrations)

During maintenance at least the following points should be checked:

- Operation of the switch contact
- Leakage test of the instrument
- Free movement of the flow

Depending on the application, it is up to the operator to determine the appropriate maintenance intervals.

### Notes

- The free movement of the float and the operation of the switching contact can be checked by varying the flow rate and observing the state of the switching contact.
- In most cases purification can be achieved by flushing the instrument with clean media. In obstinate cases (e.g. calcareous deposits) cleaning of the instrument can be done with commercial cleaners, provided that these do not attack the materials of the device.



## Operating Instruction Flow Monitor / Flow Indicator DKG, viscosity compensated Operation: float measuring principle

### 8. Troubleshooting guide

The switch contact does not react:

- The switch contact is permanent in idle position.
  1. No flow
    - ▶ Verify, that medium flows
  2. Flow too low or switch contact adjusted too high
    - ▶ Adjust switch point to a lower point.
    - ▶ Use instrument with different measuring range.
  3. Incorrect reduced (pipe diameter too small)
    - ▶ Reduce according to section 4
  4. Float got stuck (polluted)
    - ▶ Clean the instrument and ensure free movement of the float.
  5. Switch contact faulty
    - ▶ Eliminate the reason for the fault (short circuit, overload)
    - ▶ Replace switch contact, refer to section 5
  
- The switch contact is permanent in position.
  1. Flow too high and switch contact adjusted too low
    - ▶ Reduce flow
    - ▶ Adjust switch contact to a higher flow
  2. Float got stuck (polluted)
    - ▶ Clean the instrument and ensure free movement of the float
  3. Switch contact faulty
    - ▶ Eliminate the reason for the fault (short circuit, overload)
    - ▶ Replace switch contact, refer to section 5
  
- Switch point does not coincide with actual flow.
  1. No media-specific scale
    - ▶ Request a correction table or media-specific scale
  2. Incorrect reduced
    - ▶ Reduce according to section 4
  3. Instrument polluted
    - ▶ Clean the instrument
  4. Device defect
    - ▶ Return instrument for repair and calibration to manufacturer.





## Operating Instruction Flow Monitor / Flow Indicator DKG, viscosity compensated

Operation: float measuring principle

### 9. Specifications

Operating data	DKG-1		DKG-2	
Pressure	PN 10 bar		PN 10 bar	
Pressure drop	0,02 – 0,4 bar		0,02 – 0,3 bar	
Temperature max.	120°C (optional 160°C)			
Accuracy	±10% of final value			
Electrical data	SPST N.O.	SPDT	SPST N.O.	SPDT
IP65 (Plug connection DIN43650 Form A or C)	Max. 250V • 3A • 100VA	Max. 250V • 1,5A • 50VA (1)	Max. 230V • 1A • 60VA	Max. 250V • 1,5A • 50VA (1)
IP67 (with 1m sealed in cable)				
M 12x1 plug Temperature max. 85°C	Not available		Max. 125V • 3A • 60VA	Max. 125V • 1,5A • 50VA
 Atex II 2G EEx m II T6 max. 80°C (2m sealed in cable IP67)	Max. 250V • 2A • 60VA	Max. 250V • 1A • 30VA	Not available	
EEx m II T6 max. 80°C	Max. 250V • 2A • 60VA	Max. 250V • 1A • 30VA	Not available	
Output signal	The contact switches off, if minimum flow is below setpoint.			
Power supply	Not necessary (reed contacts)			
Cable diameter for IP65	6 – 8 mm		4 – 6.5 mm	
Grade of pollution	2 (EN 61058-1)			
Other plug types or cable lengths on request.				
<b>Materials</b>	<b>Brass</b>		<b>Stainless steel</b>	
Wetted parts	brass		1.4571 (316 ti)	
Spring (wetted parts)	1.4571 (316 ti)			
Glass (wetted parts)	Duran 50			
Magnets (wetted parts)	Hard-ferrite			
Housing (not wetted parts)	Aluminum			
Seals	Viton (other on request)			



## Operating Instruction Flow Monitor / Flow Indicator DKG, viscosity compensated

Operation: float measuring principle

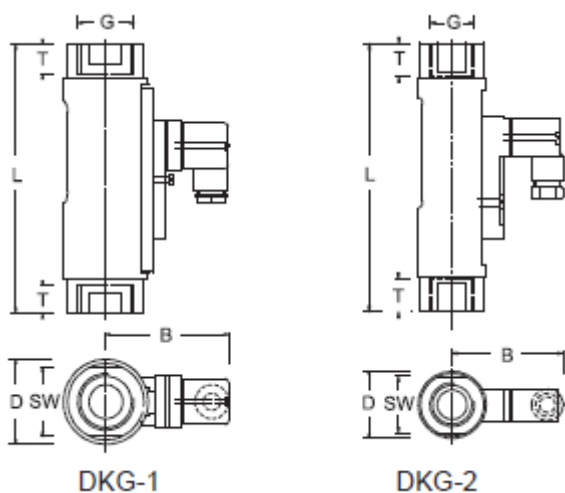

	SW	D	B	G	DN	T	L
DKG-2	27	32	53	1/2"	15	14	114
DKG-1	41	50	77	3/4" 1"	20 25	17	139 158

Overall dimensions mm